

DynaPen Series

Air-Powered Reciprocating Tool



DYNAJET
PAGE 224

COUPLER/PLUG
PAGE 228

For Engraving, Precision Removal & Deburring

FOR FILES, SCRIBE POINTS
AND CHISELS
SEE PAGES 292-293

DynaPen accepts multiple accessories for engraving, precision removal and deburring. Combining rapid action with short stroke length, DynaPen is used on plastics, composites, steel, aluminum and more. An essential tool for industries such as aerospace, mold-making, firearms, machine and model shops, plus computer and cell phone manufacturing!

Model 10843 1/8" Collet Insert (51659)

Model 10832 3 mm Collet Insert (51673)

- Lightweight pneumatic tool operates at 14,000 strokes per minute, providing fast, efficient material removal.
- Short stroke length of .007" (.018 mm) minimizes risk of gouging delicate surfaces.
- 1/8" and 3 mm Collet Inserts accept **Scribe Points, Files** and **Chisels**. Optional Collet Inserts of 1/16" (51780) and 3/32" (51674) also available.
- In-line filter prevents debris from entering tool through air line, ensuring longer tool life.
- "Easy Grip" rubber sleeve ensures comfortable and secure tool handling.
- Air line swivels 360° for greater maneuverability, especially on contoured parts.
- 95731 Wrench (included) allows quick one-step change of all accessories.

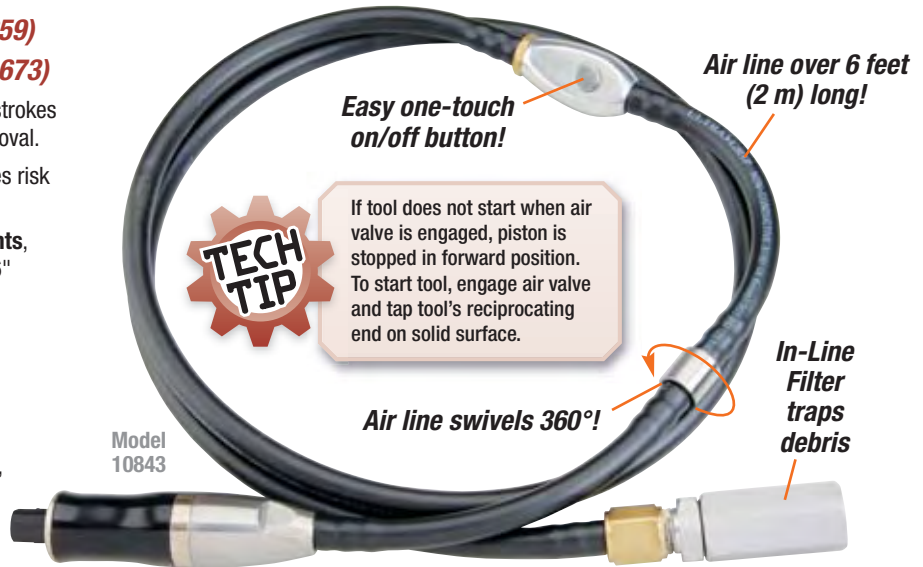

Model Number	Motor SPM	Stroke Length Inch (mm)	Maximum Air Flow SCFM (L/Min)	Sound Level	Air Pressure PSIG (Bar)	Collet Size	Weight Pound (kg)	Length Inch (mm)	Diameter Inch (mm)	Hose Length Inch (mm)
10843	14,000	.007 (.018)	4 (113)	79 dB(A)	90 (6.2)	1/8"	.57 (0.26)	4.25 (108)	.9 (23)	56 (142)
10832	14,000	.007 (.018)	4 (113)	79 dB(A)	90 (6.2)	3 mm	.57 (0.26)	4.25 (108)	.9 (23)	56 (142)

DRILLS & SPECIALTY TOOLS



Double Cut Swiss Pattern Files *(sold separately)*

Straight Files; 3-1/2" - 4" Lengths; 1/8" Dia. Tang

File/Cut	Rectangular	Square	Three Square	Half Round	Crochet	Round
Straight File "00" (Very Coarse)	90900	90910	90920	90930	90940	90950

Curved Files; 3-1/2" - 4" Lengths; 1/8" Dia. Tang

File/Cut	Rectangular	Square	Three Square	Half Round	Crochet	Round
Curved File "0" (Coarse)	90901	90911	90921	90931	90941	90951

DynaPen Scribe Points and Chisels Also Available Separately!

DynaPen Series

Air-Powered Reciprocating Tool



DYNAJET
PAGE 224

COUPLER/PLUG
PAGE 228

For Engraving, Precision Removal & Deburring

FOR FILES, SCRIBE POINTS
AND CHISELS
SEE PAGES 292-293

DynaPen Filer Kit

Includes Assortment of Popular Files!

- DynaPen with File is ideal for intricate deburring and finishing on delicate parts.
- Accepts Reciprocating Files 3-1/2" (89 mm) long, in various shapes. Three files included in Kit.

10844 Kit

- 10832 DynaPen with 51673 Collet Insert (3 mm)
- 51659 Collet Insert (1/8")
- Double Cut Swiss Pattern Files: 90900 Rectangular, 90901 Curved, 90930 Half-Round
- 95731 Wrench



10844 DynaPen Filer Kit

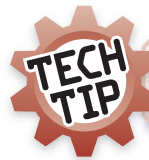

When operating DynaPen with Swiss Pattern File, move tool forward on work surface. This results in faster rate of removal.

DynaPen Scribe Kit

Includes Scribe Point for Engraving!

- DynaPen with Scribe Point easily engraves metal, wood, stone, glass and composites.
- Ideal for use in aerospace accounts and maintenance departments, where parts are engraved for identification and tracking.
- Scribe Point made of high-carbon steel, heat-treated and tempered to hardness of 62 Rockwell.

10846 Kit

- 10843 DynaPen with 51659 Collet Insert (1/8")
- 90990 Scribe Point (1/8") – High-Carbon Steel
- 95731 Wrench

10847 Kit

- 10832 DynaPen with 51673 Collet Insert (3 mm)
- 90991 Scribe Point (3 mm) – High-Carbon Steel
- 95731 Wrench

See Page 140 for DynaPen Kit with ALL Accessories!



10846 DynaPen Scribe Kit



DynaPen Series

Air-Powered Reciprocating Tool



DYNAJET
PAGE 224

COUPLER/PLUG
PAGE 228

For Engraving, Precision Removal & Deburring

FOR FILES, SCRIBE POINTS
AND CHISELS
SEE PAGES 292-293

DynaPen Chisel Kit

Includes Narrow and Wide Chisels!

- DynaPen with Chisel is effective for removing parting lines on metal and plastic.
- An important tool for dental mold-makers, jewelers, artists and archeology shops.

10848 Kit

- 10843 DynaPen with 51659 Collet Insert (1/8")
- 90992 Chisel (1/8") with 1/8" wide tip
- 90994 Chisel (1/8") with 1/4" wide tip
- 90990 Scribe Point (1/8") – High-Carbon Steel
- 95731 Wrench



10849 Kit

- 10832 DynaPen with 51673 Collet Insert (3 mm)
- 90993 Chisel (3 mm) with 3 mm wide tip
- 90995 Chisel (3 mm) with 6 mm wide tip
- 90991 Scribe Point (3 mm) – High-Carbon Steel
- 95731 Wrench

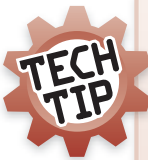

When operating DynaPen with Chisel, hold tool at angle shown. This helps prevent "scooping" or "gouging" of work surface.



DynaPen Kit

*Includes Files, Scribe Point and Chisels.
The Ultimate in Versatility!*

10850 Kit

- 10843 DynaPen with 51659 Collet Insert (1/8")
- Double Cut Swiss Pattern Files: 90900 Rectangular, 90901 Curved, 90930 Half-Round
- 90990 Scribe Point (1/8") – High Carbon Steel
- 90992 Chisel (1/8") with 1/8" wide tip
- 90994 Chisel (1/8") with 1/4" wide tip
- 95731 Wrench



10851 Kit

- 10832 DynaPen with 51673 Collet Insert (3 mm)
- Double Cut Swiss Pattern Files: 90900 Rectangular, 90901 Curved, 90930 Half-Round
- 90991 Scribe Point (3 mm) – High Carbon Steel
- 90993 Chisel (3 mm) with 3 mm wide tip
- 90995 Chisel (3 mm) with 6 mm wide tip
- 95731 Wrench

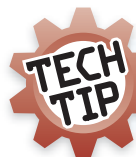

Lubrication of DynaPen is not necessary during operation. For tool storage, add one drop of oil after use, and run tool for five seconds. Tool is then lubricated for storage.

Stockade Filer

Air-Powered Reciprocating Filer



DYNASWIVEL®
PAGE 223

AIR LINES
PAGE 225

Ideal for Countless Filing Applications

FOR FILES
1/4" (6 mm) diameter tang
BELOW

Straight Line, .4 hp, Rear Exhaust

- Each model has 1/4" round file holder opening for accepting optional files with 1/4" diameter tang (see below).
- Tool includes safety-lock lever and extended rear exhaust muffler.
- Also includes built-in air flow regulator.



File Sold Separately

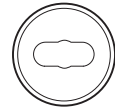

Round File Holder Opening:
6.3 mm center dia. x 13 mm width
(approx. 1/4" x 1/2")

Model 12200 2,400 Strokes/Minute

Model 12201 2,400 Strokes/Minute

- Comes with 12197 File Adapter, for mounting Dynabrade files 6" in length.



12197

Stockade Filer Kit

Model 12202

- Kit includes 12201 Stockade Filer (with 12197 File Adapter), three files (90980, 90982, 90984) and 90977 Grit-File Abrasive Kit (see below).



12202 Kit

12201

12197

90980

90982

90984

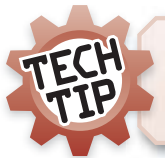

Motor Tune-Up Kits will extend the life of an air tool when used with a preventative maintenance schedule.

Model Number	Motor hp (W)	Sound Level	Maximum Air Flow SCFM (L/Min)	Stroke Inch (mm)	Strokes per Minute	Hose I.D. Size Inch (mm)	Air Inlet Thread	Weight Pound (kg)	Length Inch (mm)	Height Inch (mm)
12200	.4 (298)	86 dB(A)	21 (595)	13/32 (10)	2,400	3/8 (10)	1/4" NPT	2.4 (1.1)	10 (254)	1-1/2 (38)
12201	.4 (298)	86 dB(A)	21 (595)	13/32 (10)	2,400	3/8 (10)	1/4" NPT	2.4 (1.1)	10 (254)	1-1/2 (38)

Tune-Up Kit: No. 96261 (page 267) • Additional Specifications: Air Pressure 90 PSIG (6.2 Bar)

Dynabrade Files (6" Length) • Sold Separately

Part Number	Name	Shape	Tang	Cut
90980	Rectangular		Ø 1/4" (Ø 6 mm)	Swiss Double Cut "00" (Very Coarse)
90981	Half Round		7/16" x 3/32" (11 mm x 2.5 mm)	Swiss Double Cut "00" (Very Coarse)
90982	Round		Ø 1/4" (Ø 6 mm)	Swiss Double Cut "00" (Very Coarse)
90983	Triangular		Ø 1/4" (Ø 6 mm)	Swiss Double Cut "00" (Very Coarse)
90984	Square		Ø 1/4" (Ø 6 mm)	Swiss Double Cut "00" (Very Coarse)
90985	Rectangular		Ø 1/4" (Ø 6 mm)	Swiss Double Cut "0" (Coarse)
90986	Half Round		7/16" x 3/32" (11 mm x 2.5 mm)	Swiss Double Cut "0" (Coarse)
90988	Triangular		Ø 1/4" (Ø 6 mm)	Swiss Double Cut "0" (Coarse)
90989	Square		Ø 1/4" (Ø 6 mm)	Swiss Double Cut "0" (Coarse)
90905	Rectangular		1/4" x 7/64" (6 mm x 2.8 mm)	Aluminum, Curved, 16 TPI

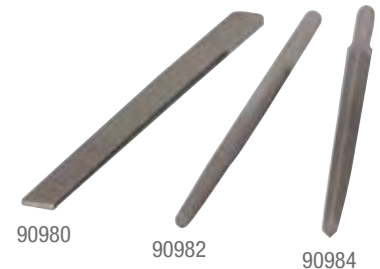

90980

90982

90984

Ø = Diameter; TPI = Teeth Per Inch

Stockade Sander and Saw

Air-Powered Reciprocating Sander and Saw



DYNASWIVEL®
PAGE 223

AIR LINES
PAGE 225

Ideal for Countless Sanding and Sawing Applications

FOR ABRASIVE STRIPS,
SAW BLADES
SEE BELOW

Stockade Sander

Model 12204 2,400 Strokes/Minute

- Has 5" long x 1/2" wide spring-steel extender which accepts stick-on coated abrasive strips (sold separately).
- 80 and 180 grit abrasive strips are included.
- Three platen pads are included, which may be mounted to the extender as a backing for the abrasive strip.
- Safety-lock lever and extended rear exhaust muffler included.

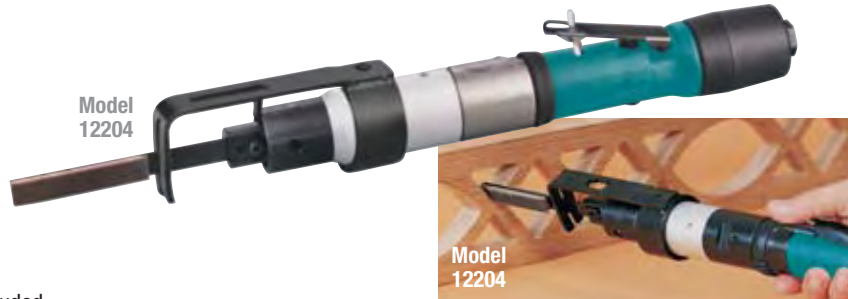

Stockade Saw

Model 12205 2,400 Strokes/Minute

- Tool includes 12212 Saw Holder Adapter, 12183 Saw Guide, 90935 General Purpose Saw Blade.
- Built-in air flow regulator.
- Countless applications on wood, metal, composites, fiberglass and more.
- Safety-lock lever and extended rear exhaust muffler included.



Stockade Saw Kit

Model 12206 2,400 Strokes/Minute

- 12205 Stockade Saw (above) and 90933 Saw Blade Pack, which includes one of each blade shown at right (six total).
- 12183 Saw Guard Assembly (must be used with saw blades).
- Saw Blades have a variety of uses on metal, fiberglass, wood and more.

12206 Kit



Dynabrade Saw Blades • Sold Separately

Part Number	Blade Type	Description	Shape
90934	Metal/Fiberglass Cutting	Silver • Long Life • Bi-Metal	
90935	Metal Cutting	White • Long Life • Bi-Metal	
90936	Metal Cutting	White • Long Life • Bi-Metal	
90937	Metal Cutting	White • Long Life • Bi-Metal	
90938	Metal Scroll Heavy Duty	White • Long Life • Bi-Metal	
90939	Wood Cutting/Stiff Back	White • Bi-Metal	

Stockade Filer/Saw Kit

Model 12207 2,400 Strokes/Minute

- 12205 Stockade Saw (above).
- Three adapters: 12197 for Dynabrade 6" long files; 12211 for foundry file; 12212 for saw blades.
- 12183 Saw Guard Assembly (must be used with saw blades).
- Two 6" long files (90980 Pillar; 90983 Triangular).
- One 5-1/2" long foundry file (90905).
- Two saw blades (90934, 90935).

12207 Kit



Model Number	Motor hp (W)	Sound Level	Maximum Air Flow SCFM (L/Min)	Stroke Inch (mm)	Strokes per Minute	Hose I.D. Size Inch (mm)	Air Inlet Thread	Weight Pound (kg)	Length Inch (mm)	Height Inch (mm)
12204	.4 (298)	86 dB(A)	21 (595)	13/32 (10)	2,400	1/4 (6)	1/4" NPT	2.4 (1.1)	10 (254)	1-1/2 (38)
12205	.4 (298)	86 dB(A)	21 (595)	13/32 (10)	2,400	3/8 (10)	1/4" NPT	2.4 (1.1)	10 (254)	1-1/2 (38)

Tune-Up Kit: No. 96261 (page 267) • Additional Specifications: Air Pressure 90 PSIG (6.2 Bar)

DRILLS & SPECIALTY TOOLS

Dynadie® III

Air-Powered Reciprocating Filer



DYNAJET
PAGE 224

COUPLER/PLUG
PAGE 228

Reciprocating Filer for Precise Filing and Finishing

FOR TANGED FILES
1/8" (3 mm) and 1/4" (6 mm) dia.
SEE BELOW

Model 12250 Variable-Length Stroke

- Accepts 1/4" dia. or 1/8" diameter tanged files. Files sold separately.
- Replaces tedious hand filing. Easily enters narrow slots.
- Use on metal, wood, plastic, fiberglass, etc.
- Variable-length stroke from 0-1/4". Tool runs at 5,000 strokes per minute.
- Barrel indexes 360° for ideal comfort.
- Tool includes 94407 Flow-Control Dynaswivel® (not shown).



Model Number	Motor hp (W)	Sound Level	Maximum Air Flow SCFM (L/Min)	Stroke Inch (mm)	Strokes per Minute	Hose I.D. Size Inch (mm)	Air Inlet Thread	Weight Pound (kg)	Length Inch (mm)	Height Inch (mm)
12250	.2 (142)	76 dB(A)	18 (509)	0 - 1/4 (6)	5,000	3/8 (10)	1/4" NPT	1.8 (.82)	6-5/8 (170)	4-1/8 (106)

Tune-Up Kit: No. 96533 (page 267) • Additional Specifications: Air Pressure 90 PSIG (6.2 Bar)

Straight Double Cut Swiss Pattern Files 6" Length; 1/4" Dia. Tang

Cut	Rectangular	Round	Three Square	Square
"00" (Very Coarse)	90980	90982	90983	90984
"0" (Coarse)	90985	-	90988	90989

Straight & Curved Double Cut Swiss Pattern Files 3-1/2" - 4" Lengths; 1/8" Dia. Tang

File/Cut	Rectangular	Square	Three Square	Half Round	Crochet	Round
Straight File "00" (Very Coarse)	90900	90910	90920	90930	90940	90950
Curved File "0" (Coarse)	90901	90911	90921	90931	90941	90951

Router

Air-Powered Routing Tool



DYNAJET
PAGE 224

COUPLER/PLUG
PAGE 228

Ideal for Countless Routing Applications

FOR ROUTER BITS
1/8" (3 mm) and 1/4" (6 mm) dia. shanks
NOT INCLUDED

Model 51330 20,000 RPM, .7 hp, Front Exhaust

- Ideal for chamfers and roundover cuts on hardwoods, softwoods, solid surfaces or plastics. Great for laminate trimming, surface planing, beveling and cornering.
- Tool accepts optional high-speed steel router bits with 1/4" diameter shank capacity. Also accepts optional 1/8" collet insert, for mounting 1/8" diameter router bits.
- Lightweight, non-marring composite fixed base allows for 90° cuts. Base offers easy height adjustment.
- Safety-lock lever is standard.
- Front exhaust directs chips away from cutter.
- Spindle lock allows one-wrench cutter changing.
- Includes guide rails, ideal for use on glue seams.



Router Bit
Not Included

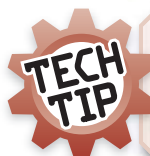

Motor Tune-Up Kits will extend the life of an air tool when used with a preventative maintenance schedule.

Model 51331 Router Kit

- Includes 51330 Router with 93388 six-piece router bit set.

Model Number	Motor hp (W)	Motor RPM	Sound Level	Maximum Air Flow SCFM (L/Min)	Hose I.D. Size Inch (mm)	Air Inlet Thread	Spindle Thread	Weight Pound (kg)	Base Size Inch (mm)	Height Inch (mm)
51330	.7 (522)	20,000	82 dB(A)	34 (963)	3/8 (10)	1/4" NPT	3/8"-24 Male	2.5 (1.1)	3-1/4 (83) x 3-1/2 (89)	8-1/4 (210)

Tune-Up Kit: No. 96529 (page 267) • Additional Specifications: Air Pressure 90 PSIG (6.2 Bar) • Collet Depth 1-5/8" (41 mm) • Max. Cutter Dia. 1-1/8" (29 mm)

DRILLS & SPECIALTY TOOLS

Vacuum Router

For Connection to Central Vacuum System



DYNAJET
PAGE 224

COUPLER/PLUG
PAGE 228

Unique Vacuum Shroud Captures Contaminants

- Vacuum Router is ideal for chamfers and roundover cuts on hardwoods, softwoods, solid surfaces and plastics. Great for laminate trimming, surface planing, beveling and cornering.
- Includes 1" vacuum port, for easy connection to external central vacuum system. Efficiently captures dust and debris as tool is run.
- Tool accepts optional high-speed router bits with 1/4" diameter shank capacity.
- Non-marring composite base.
- Safety-lock throttle lever included.
- Also includes 94300 Composite Dynaswivel®, for enhanced tool maneuverability.

FOR ROUTER BITS
1/8" (3 mm) and 1/4" (6 mm) dia. shanks
NOT INCLUDED



3-1/2" (89 mm) Base Model

Model 51332 .7 hp (522 W), 20,000 RPM

Includes 94300 Composite Dynaswivel® Air Line Connector (both models)

Safety-lock lever is included (both models)

Includes 08054 Insert, for enhanced source capture (both models)



Adjustable roller guide ensures consistent cut path on edge work



4" (102 mm) Base Model

Model 51333 .7 hp (522 W), 20,000 RPM

Extended rear exhaust muffler for reduced sound levels (both models)

Two handles for added support and ease of use

4" (102 mm) dia. Composite Base offers enhanced stability

1" Dia. Vacuum Port



DRILLS & SPECIALTY TOOLS

Model Number	Motor hp (W)	Motor RPM	Sound Level	Maximum Air Flow SCFM (L/Min)	Collet Size	Air Inlet Thread	Weight Pound (kg)	Length Inch (mm)	Height Inch (mm)
51332	.7 (522)	20,000	79 dB(A)	37 (1,048)	1/4"	1/4" NPT	2.6 (1.2)	11 (282)	3.5 (89)
51333	.7 (522)	20,000	79 dB(A)	37 (1,048)	1/4"	1/4" NPT	3.3 (1.5)	11 (282)	4 (102)

Tune-Up Kit: No. 96259 (page 267) • Additional Specifications: Air Pressure 90 PSIG (6.2 Bar)

Dynascaler

Air-Powered Descaling and Surface Preparation Tool

For Heavy-Duty Industrial, Marine, Construction Applications

FOR "BONDED SHOT"
FLAP ACCESSORIES
SEE PAGE 293

- All models use optional "bonded shot" flap assemblies.
- Ideal for weld preparation, plus removing rust, oxide, scale, old paint and tough coatings.

Hand-Held Models

- Steel dowel pin (keepers) system allows easy flap loading and unloading.
- Four-position top handle adjusts for operator comfort.

Model 30304 *Straight Line*

- For 2" wide work on inside of pipe.
- Six-slot hub (2-1/4" wide) accepts optional "bonded shot" flap assemblies. Adjustable for exact positioning of flap assemblies to surface.

Model 30336 *Straight Line*

Model 30337 *Right Angle*

- Each model is for 2" wide work on flat surfaces.
- Ideal for removal of floor paint/coatings and for scarifying concrete.
- Vacuum port accepts 1-1/2" diameter cuff.
- Model 30337 is USA Government National Stock Number 389501149337.



Model 30304



Model 30336

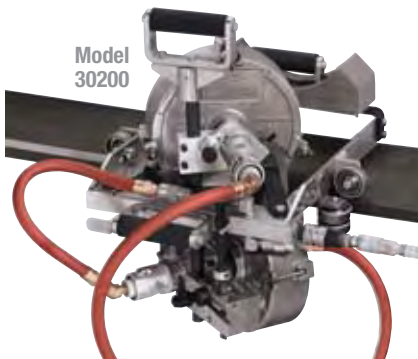

Model 30200

Over-Under Model

Model 30200 *1" Wide Top and Bottom*

- Mechanically fractures scale and coatings, with negligible removal of base metal.
- "Over-under" simultaneous removal of scale, from top and bottom of girder webplates prior to welding.
- Top and bottom unit each use optional 1" wide "bonded shot" flap assemblies. Top unit easily detaches to permit portable "touch up" descaling.

Floor Models

Model 30303 *2" Wide*

Model 31600 *3" Wide*

- Each model has 20-slot hub for optional "bonded shot" flap assemblies.
- Adjustable edge guide assures straight-line descaling. (Not recommended for use without edge guide.)

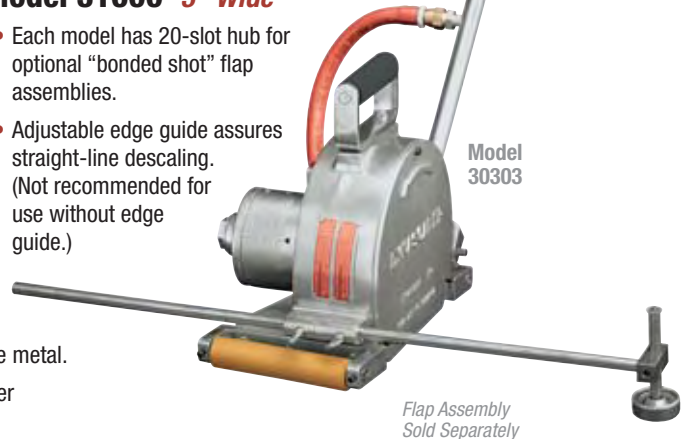

Model 30303

Flap Assembly
Sold Separately

Model Number	Motor hp (W)	RPM Free Speed	RPM Under Load	Sound Level	Maximum Air Flow SCFM (L/Min)	Hose I.D. Size Inch (mm)	Spindle Thread	Weight Pound (kg)	Length Inch (mm)	Height Inch (mm)
30303	1.7 (1,268)	3,000	1,650	94 dB(A)	78 (2,209)	1/2 (13)	–	44.2 (20)	8-3/4 (222)	11 (279)
31600	4.0 (2,983)	3,000	1,650	94 dB(A)	127 (3,597)	1/2 (13)	–	54 (24.5)	8-3/4 (222)	11 (279)
30200	.7 (522)	3,400	2,100	94 dB(A)	38 (1,076)	1/2 (13)	–	33.2 (15)	14 (355)	10-3/4 (273)
30304	.7 (522)	3,400	2,400	92 dB(A)	38 (1,076)	1/2 (13)	1/2"-20 Male	6.2 (2.8)	11-3/4 (298)	8-1/4 (210)
30336	.7 (522)	3,400	2,400	92 dB(A)	38 (1,076)	1/2 (13)	1/2"-20 Male	6.5 (2.9)	11-3/4 (298)	8-1/4 (210)
30337	.7 (522)	3,100	1,950	94 dB(A)	38 (1,076)	1/2 (13)	1/2"-20 Male	6.5 (2.9)	11-3/4 (298)	8-1/4 (210)

Tune-Up Kit: No. 96260 (page 267) • Additional Specifications: Air Pressure 90 PSIG (6.2 Bar), Air Inlet Thread 3/8" NPT